

dataTale **Guardian**  
*2.5-inch Encrypted HDD Enclosure*

USB 2.0  
AES 256-bit



*User's Manual*



## Table of Contents

<b>GENERAL INFORMATION .....</b>	<b>3</b>
COPYRIGHT.....	3
NOTICES AND CLASSIFICATIONS .....	3
CONTACT US.....	3
<b>PRECAUTIONS FOR THE ENCLOSURE .....</b>	<b>4</b>
GENERAL PRECAUTIONS.....	4
ENCRYPTED HDD ENCLOSURE PRECAUTIONS.....	4
<b>INTRODUCTION.....</b>	<b>5</b>
FEATURES.....	5
<b>SYSTEM REQUIREMENT .....</b>	<b>6</b>
PC.....	6
MAC.....	6
PACKAGE CONTENTS .....	6
<b>SYSTEM UNIT VIEW.....</b>	<b>7</b>
FRONT VIEW .....	7
<b>ASSEMBLING THE HDD ENCLOSURE .....</b>	<b>8</b>
<b>CONNECTING THE ENCLOSURE TO A COMPUTER .....</b>	<b>11</b>
<b>SAFE REMOVAL OF THE UNIT.....</b>	<b>13</b>
<b>LED STATUS.....</b>	<b>13</b>
<b>Q&amp;AS .....</b>	<b>13</b>
HDD STATUS .....	13
SECURE KEY FEATURE .....	13
FILE SYSTEM FORMAT.....	14
DISCREPANCY IN REPORTED & ACTUAL SIZE CAPACITY.....	14
<b>APPENDIX: SPECIFICATIONS .....</b>	<b>15</b>

# **GENERAL INFORMATION**

## **COPYRIGHT**

Copyright © 2010 ONNTO Corporation. All rights reserved. No part of this publication may be reproduced, stored in a retrieval system, or transmitted in any form or by any means, electronic, mechanical, photocopying, recording or otherwise, without the prior written consent of ONNTO Corporation.



The product information provided in this manual is subject to change without prior notice and does not represent a commitment on behalf of the vendor. The vendor assumes no liability or responsibility for any errors that may appear in this manual.

## **NOTICES AND CLASSIFICATIONS**

### ***FCC-B Radio Frequency Interference Statement***

This device complies with Part 15 of the FCC rules. Operation is subject to the following two conditions:

This device may not cause harmful interference.

This device must accept any interference received, including interference that may cause undesired operation.



This equipment has been tested and found to comply with the limits for a Class B digital device, pursuant to Part 15 of the FCC rules. These limits are designed to provide reasonable protection against harmful interference when the equipment is operated in a commercial environment. This equipment generates uses and can radiate radio frequency energy and, if not installed and used in accordance with the instruction manual, may cause harmful interference to radio communications.

## **CONTACT US**

We are committed to offer economical, high-quality connectivity and storage enclosure solutions to the market. Your questions, inquiries or comments are welcomed. For Technical Support, software or User Manual updates, please go to our website at [www.onnto.com.tw](http://www.onnto.com.tw)

### **ONNTO Corporation**

3F, No. 60, Lane 321, Yang Guang St.,

Nei Hu, Taipei 114 Taiwan

Tel: +886-2-8797-8868

Fax: +886-2-8797-4801

Email: [question@onnto.com.tw](mailto:question@onnto.com.tw)

# **PRECAUTIONS FOR THE ENCLOSURE**

## **GENERAL PRECAUTIONS**

- ◆ The main circuit board of the Enclosure is susceptible to static electricity. Proper grounding is required to prevent electrical damage to the Enclosure or other connected devices, including the host computer. **Always** place the Enclosure on a smooth surface and avoid all dramatic movement, vibration and percussion.
- ◆ Do **NOT** allow water to enter the Enclosure.
- ◆ Do **NOT** place the Enclosure close to magnetic devices (such as a mobile phone), high-voltage devices (such as a hair dryer), or near a heat source (such as on the dashboard of a car or any place where the Enclosure will be exposed to direct sunlight).
- ◆ **Use only** the bus-powered USB cable provided with the Enclosure.
- ◆ **Use only** a 9.5mm high 2.5" HDD inside the Enclosure. The Enclosure may not function properly if a HDD with a different thickness is used. In addition, the Enclosure and HDD may be damaged.

## **ENCRYPTED HDD ENCLOSURE PRECAUTIONS**

- ◆ Required to partition and format the hard drive after installing it inside the Enclosure. Always perform partition and format of a new disk drive with one of the provided Secure Keys inserted in the Enclosure.
- ◆ After the Enclosure is **properly connected** to the host computer, **insert the Secure Key** to allow proper disk enumeration. The Secure Key **may be removed** after the host computer has detected the Enclosure.
- ◆ **Keep the Secure Key with you** at all times, as it is required for authenticating the Encrypted HDD Enclosure when connected. Without the Secure Key's presence, the host computer will not be able to detect the Encrypted HDD.

# INTRODUCTION

Thank you for purchasing the DataTale Guardian (EU-S10-Y). This Encrypted 2.5-inch SATA HDD Enclosure provides secure data access and convenient travel for your slim 2.5-inch hard drive. Guardian is a secure-data storage device that has adopted Enova real-time hardware AES (Advanced Encryption Standard) cryptographic processor, making Guardian one of the finest secure-data mobile HDD Enclosure in the world with privacy protection on data. The hardware (AES-256) is NIST (National Institute of Standard & Technology of USA) and CSE (Communication Security Establishment of Canada) certified. It is utilized to encrypt all sensitive and confidential data inside the HDD (including boot sector, temporary files, and the operating system). Proper installation, care, and usage of the Enclosure Kit as described in the User's Manual will ensure trouble-free utility and prolong life of the DataTale Guardian.



Please thoroughly read and follow the instructions provided in this manual. Failure to do so may result in damage to the Enclosure Kit, and any or all of the connected devices.

## Features

- ✚ Supports current SATA II compliant HDDs, fully backward compatible with SATA 1.0 and SATA 1.0a compliant HDDs
- ✚ Provides real-time cryptographic strength with encryption length up to 256-bit
- ✚ Supports Hi-Speed USB (USB2.0 connection)
- ✚ Connects to host by plug-n-play, not requiring any IT expertise or software installation
- ✚ Powers HDD via USB bus power
- ✚ Indicates most-updated statuses easily via hidden LED
- ✚ Supports hot-plug
- ✚ Comes with Secure Keys for encrypted security function, no need to memorize any passwords
- ✚ Protects casing & HDD via copper-pillar reinforced screw guides for constant swapping



**Data Loss** may occur if the Enclosure is **reformatted** or utilize for regular usage without the Secure Key inserted. Please review Connecting The Enclosure To A Computer and Q&A sections for more information.



Any loss, corruption, or destruction of data is the **sole responsibility of the user**. Under no circumstances will the manufacturer be held liable for the recovery or restoration of any data.

## **System Requirement**

To use the Enclosure Kit, the minimum system configuration in the host computer require the following:

### **PC**

- ✚ 266MHz or faster CPU (800MHz or faster CPU is required for Windows Vista)
- ✚ 64MB of RAM (512MB or more of RAM is required for Windows Vista)
- ✚ Microsoft Windows 2000, XP, 2003, Vista, 2007 or higher
- ✚ One available USB 2.0 port

### **MAC**

- ✚ Macintosh PowerPC or Intel processor
- ✚ 64MB of RAM (256MB or more of RAM is required for Mac OS X 10.4)
- ✚ Mac OS X 10.1 or higher
- ✚ One available USB 2.0 port

 2.5-inch SATA compatible hard drive is required for the Enclosure. Once the HDD is formatted, the actual available storage capacity can vary depending on the selected operating environment (normally 5-10 % less).

## **Package Contents**

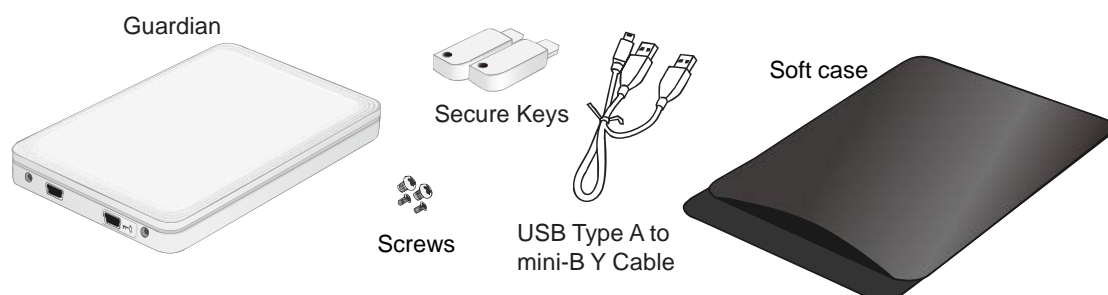

 Please keep all package contents and packaging material in the event that the product must be returned.

# **SYSTEM UNIT VIEW**

## **Front View**

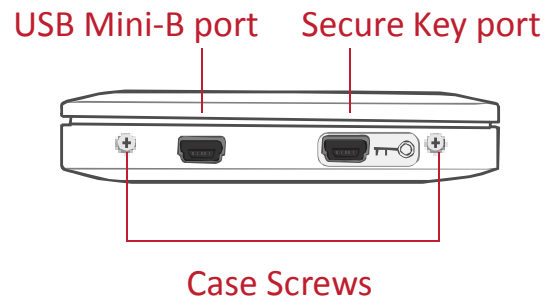

 The hidden LED on its top cover will indicate statuses for Power, Data Access and Secure Key authentication.

## **ASSEMBLING THE HDD ENCLOSURE**

To begin using the Enclosure Kit, simply install a 2.5" SATA hard drive in the Enclosure and complete the assembly steps outlined below:

1. Firmly push the lid down from front to back and open the Enclosure. After the lid is opened, the PCBA board (Printed Circuit Board) should be securely in place inside the Enclosure. One package containing the two HDD Screws and two Case Screws should be attached.



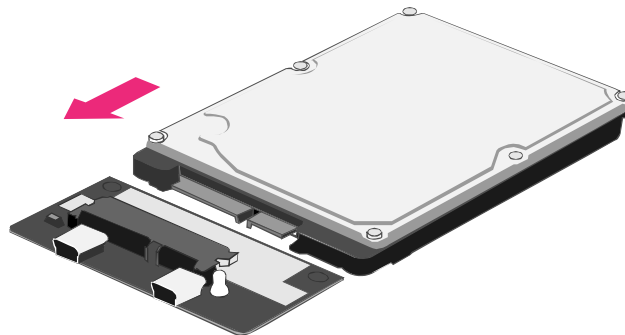

2. Carefully take out the PCBA board from the Enclosure. Align the SATA connector of the hard drive with the PCBA board. Carefully insert the SATA connector into the slot on the PCBA board until it's firmly connected.



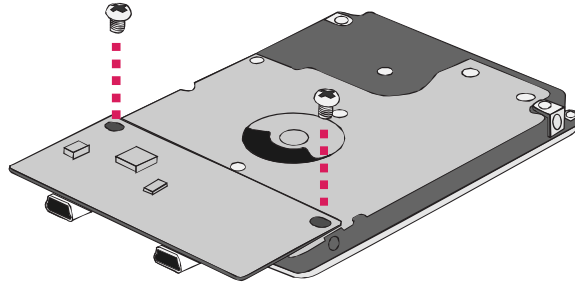

3. Turn the hard drive connected to the PCBA board to its backside. Locate two larger (HDD) screws enclosed inside the package. Tighten the screws in its appropriate holes, ensuring that the hard drive and PCBA alignment is properly maintained.



 The smaller (Case) screws are for fastening the Enclosure's housing and lid together.

4. Carefully align the PCBA board, with the hard drive attached, to the Enclosure port opening(s) inside the Enclosure. The two holes of the HDD end, where it is not attached to the PCBA, will match up to the ribs inside the housing.

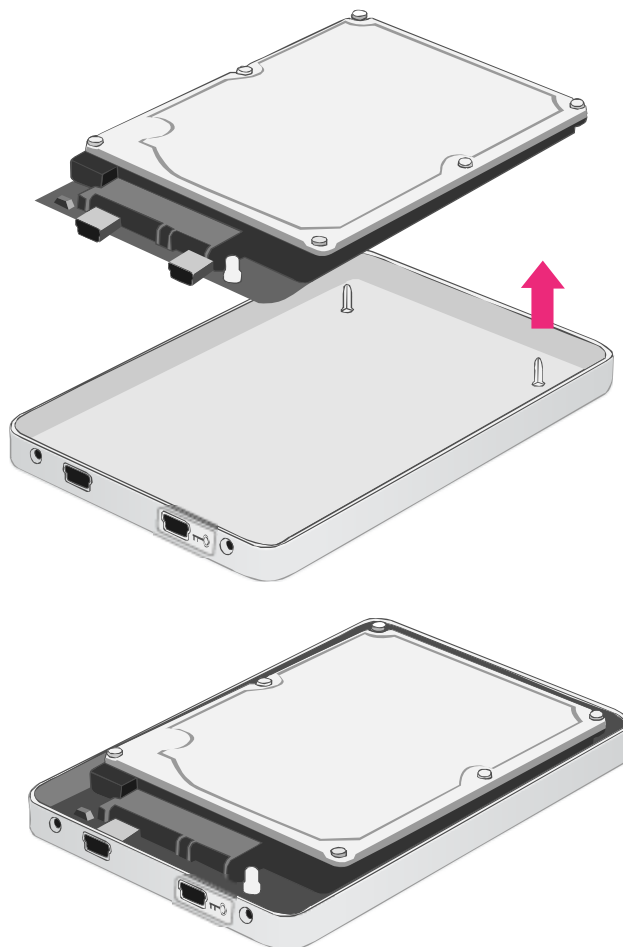

5. Place the lid on top of the Enclosure. Make sure the two copper screw holes are aligned with Front View. Firmly push the lid down from back to front and lock the lid on the Enclosure. Make sure the lid is securely in place.





6. Find the two smaller (Case) screws enclosed inside the package and fasten them to attach the lid onto the Enclosure (Front View).



## CONNECTING THE ENCLOSURE TO A COMPUTER

Complete the following steps to connect the Enclosure Kit to a host computer:

 Please partition and format the hard drive first after assembling it inside the Enclosure Kit. Always perform partition and format functions with the Secure Key inserted. Partitioning and formatting operations will erase all existing data on the hard disk. Remember to backup all existing data from the hard disk before performing any partitioning or formatting operations to prevent loss of data.

1. Power “on” the host computer.
2. Insert the Secure Key into the Secure Key port indicated by the Secure Key icon “” on the Front view of the Enclosure Kit before plugging in the USB2.0 connector.





 Always plug in the Secure Key **first** every time the Enclosure Kit is connected to a host. The Secure Key may be removed after the host computer detects the Enclosure.

3. Insert the USB2.0 connector into the corresponding port in the Enclosure Kit and the host computer. The host computer should automatically detect the Enclosure.

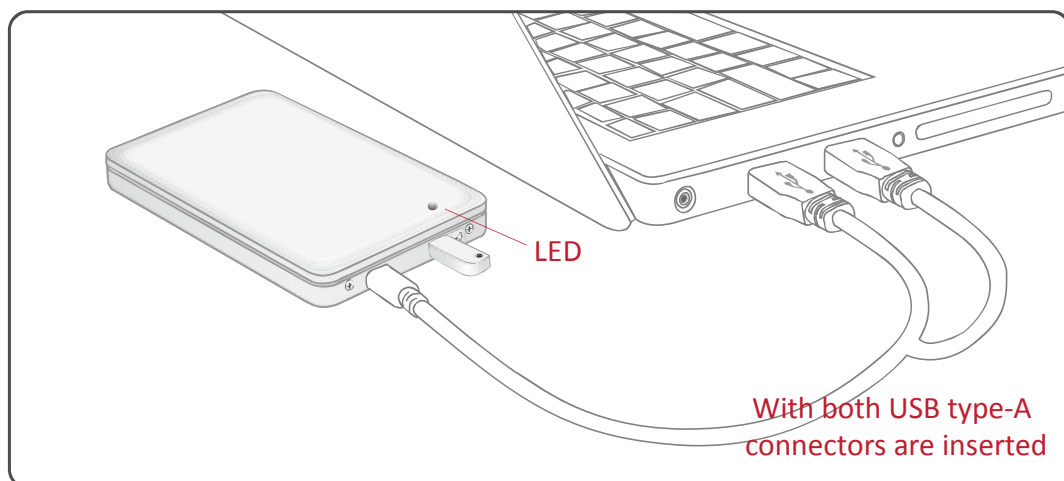
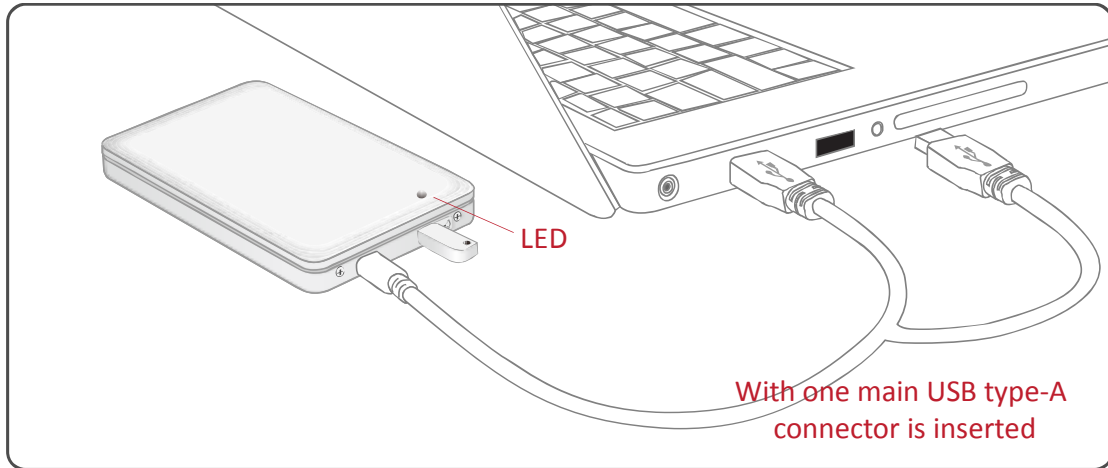

 If the LED indicator is red, it is because the host cannot access the HDD and the Secure Key is not inserted. To solve the problem: First, completely unplug the USB cable to power off the Enclosure Kit. Second, insert the Secure Key. Third, re-plug the USB cable to power on the Enclosure again.



 The USB Y-cable provides 2 USB type-A connectors and 1 USB mini-B connector. The 2 USB type-A connectors are inserted into two available USB ports on the computer. The USB Y-cable serves as both power supply and data transfer cable. When the host computer doesn't supply enough power to start up the HDD under only one USB connector, plug in the second type-A connector into the host computer.

4. When successfully connected, the hidden LED will light up on the lid (near its Front View) and become steadily blue. When the HDD is being access, the hidden LED (at the same place) will flash in blue. Now, the Enclosure Kit is ready to be used!

## **SAFE REMOVAL OF THE UNIT**

Safe removal of the Unit from the host is highly recommended. In order to safely remove your Enclosure from the host controller, you would need to eject the device on your host system.

## **LED STATUS**

LED COLOR	STATUS
BLUE	KEY OK
FLASHING BLUE	DATA ACCESS
RED	NO KEY

## **Q&As**

### **HDD Status**

**Q:** What are the indications of HDD status, reflected by the hidden LED?

**A:** When connected, the hidden LED will light up and one small part on the lid toward its Front View will become steadily blue. If the HDD is being accessed, the hidden LED at the same place will flash in blue. If the Secure Key is not inserted, the hidden LED will become red.

**Q:** Can I use my old HDD for this new Enclosure Kit?

**A:** Yes, as long as it is a SATA interface HDD. Because installation involves reformatting/partitioning of the HDD, all previous data stored on your HDD will be lost. First, make sure that you've kept a good copy of the data from your HDD prior to installation. Then, copy this data onto the Enclosure Kit once installation has been completed.

### **Secure Key Feature**

**Q:** What are the limitations or precaution for the Secure Key feature?

**A:** Every time after the Enclosure Kit is properly connected to the host computer, insert the Secure Key to allow proper disk enumeration. The Secure Key may be removed after the host computer has detected the Enclosure Kit. The Secure Key feature is only utilized for "data protection", not "HDD thief protection".

**Q:** I have 2 sets of Guardian HDD Enclosures. If I mixed up the Secure Keys and plug in the wrong one, what will happen?

**A:** When the wrong Secure Key is inserted into the Enclosure Kit, the host will detect the Enclosure Kit as a new device until the correct Secure Key (the key which was inserted when performing partitioning and formatting at the beginning) is plugged in.

*Note: This is only referring to same product models. Results may vary depending on each product model.*

## File System Format

**Q:** I would like to format my hard drives with the FAT (a.k.a. File Allocation Table) format, which can be read and written by both Mac and PC. Is there any limitation on its capacity?

**A:** Yes, please check the table below for reference.

File System	NTFS	FAT32	FAT (Format by Win2000 / WinXP)	FAT16
<b>Capacity Limitation</b>	Vista: 16384TB XP: 2TB	Windows: 32GB Mac: 2TB	4GB	2GB

## Discrepancy in Reported & Actual Size Capacity

**Q:** If I have a 320GB HDD, why does the Enclosure only recognizes the HDD available space as to be less than 320GB?

**A:** Many customers are confused by their host systems when it reports a discrepancy between reported capacity and actual capacity. Several factors can come into play when your host system views and reports the capacity of a hard drive. There are actually two different numbering systems used to express units of storage capacity:

**Binary**, which says that a kilobyte is equal to 1024 bytes; and  
**Decimal**, which says that a kilobyte is equal to 1000 bytes.

Most commonly used to display storage capacity is in Decimal. The surprising fact is that even though it seems like you will have more bytes under Binary, the Decimal calculation system actually presents a greater storage capacity. More information on capacity issues can be found at the Seagate website under FAQs.

[http://www.seagate.com/ww/v/index.jsp?locale=en-US&name=Storage\\_Capacity\\_Measurement\\_Standards\\_-\\_Seagate\\_Technology&vgnnextoid=9493781e73d5d010VgnVCM100000dd04090aRCRD](http://www.seagate.com/ww/v/index.jsp?locale=en-US&name=Storage_Capacity_Measurement_Standards_-_Seagate_Technology&vgnnextoid=9493781e73d5d010VgnVCM100000dd04090aRCRD)

## **APPENDIX: SPECIFICATIONS**

<b>Model Name</b>	<b>EU-S10-Y</b>
<b>Interface</b>	USB 2.0 x 1
<b>HDD Support</b>	2.5" SATA HDD
<b>Encryption Type</b>	AES 256-bit
<b>Data Transfer Speed</b>	USB 2.0: up to 480Mbit/sec
<b>System Material</b>	Plastic casing
<b>Status Indicator</b>	Power On / Access / Power Off / Key Insertion
<b>Power Supply</b>	Bus power from host via mini USB cable
<b>Security</b>	Secure Keys
<b>Dimension</b>	123 (L) x 80 (W) x 16 (H) mm
<b>Weight (without HDD)</b>	86 G
<b>Certification</b>	CE, FCC